

# Read 'awl' about it

Newsletter from

## The Cannock Chase Shed

Issue No. 37

Submissions and suggestions to Bob Mason at:

[shednewsletter@virginmedia.com](mailto:shednewsletter@virginmedia.com)

week ending Sat 24<sup>th</sup> July 2021

### In This Issue....

- Shed News
- Meet the Committee
- Notices
- Crossword No 15
- Project – Cordless Drill Organiser & Battery Charging Station
- Wordsearch – Scottish Premier League
- Humour
- Latest Scams
- Project – Lap Desk
- Answers to Puzzles



# Shed News

[enquiries@cannockchaseshed.org.uk](mailto:enquiries@cannockchaseshed.org.uk) goes directly to all Committee Members to answer as necessary should anyone wish to give information or make any comment.

## Check our webpage...

...for information about our Shed, updates about reopening and back issues of the newsletter.

<https://cannockchaseshed.org.uk/>

## We are on Facebook...

Remember we have a Facebook page, where you can chat with friends, exchange ideas or ask for advice, as well as sharing your projects.

If you are having trouble finding the bits you need for your project, why not post a request? Another member may have just what you're looking for sitting unused in their garage, or they may know where you can get one.

If you have useful items that you are loath to throw away, why not put up a post, offering them to other members, before consigning them to the tip?

## Official Facebook page: Private Group

<https://www.facebook.com/groups/cannockchaseshedders>

## Meet the Committee

<b>Dave Shaw</b>	<b>Chairman</b>
<b>Leslie Jukes</b>	<b>Deputy chairman</b>
<b>Barry James</b>	<b>Health &amp; Safety</b>
<b>Avril Green</b>	<b>Fundraising/Secretary</b>
<b>Graham Johnson</b>	<b>Treasurer</b>
<b>Tim Cutler</b>	<b>Project Manager</b>

## Shed Media

<b>Peter Ross</b>	<b>Website/Facebook Group</b>
<b>Bob Mason</b>	<b>Newsletter</b>

## Could you...



- Sort through your photos and send me a picture and a few words? – your pet, garden, favourite holiday, your most useful tool, a current or past project, a cooking success (or disaster) or favourite recipe? – Pretty much anything you like.
- send me a suggestion of something you'd like to see included in the newsletter? – anything from just a broad idea, to a finished article.
- send in a 'reader's letter'? Share an anecdote or treasured memory? Share your expertise with those who have less experience?
- Send in something else, or help in another way that I haven't even mentioned?

Or if your shy pass it to one of the committee!!!

# Notices

Can any member wishing to book a session either on Monday morning or Monday afternoon on the 26th of July please phone me on 07964851114.

The hours for the morning are:

9-30am to 12-30pm

and the afternoon is:

1-00pm to 4-00pm.

Also, a reminder that to book a session you will need to have had both covid vaccine jabs or if you haven't had the jabs you will need to take a lateral flow test at least 12 hours before coming to the Shed.

I understand that most members prefer mornings because of other commitments in the afternoon but as we are now paying £15 a day could some members please try and book an afternoon, it would also spread out the amount of members in any one session. We will also need a supervisor for each session so if any member who is present at one of the sessions can do that it would be much appreciated.

Cleaning, washing up, tidying etc: needs to be started at least 15mins before the end of each session and maybe a little earlier in the afternoon as the keys have to be returned to the museum for 4-15pm.

Lastly, due to Government restrictions being extended until July 19th social distancing and wearing masks inside the Shed will still be required. If you don't have a mask with you, one can be supplied.

If anyone has changed their phone number or email address since first joining the Shed can they please send the new details to Graham at [enquiries@cannockchaseshed.org.uk](mailto:enquiries@cannockchaseshed.org.uk) so he can update his records.

Diary Dates: **3<sup>rd</sup> August** – 10:30 Shed AGM (Provisional)

CCShed Membership status:

Extended Membership ends this month (June) and Annual Fees will again be due on 1st July 2021. Reduced this year to £17.50. Please pay Treasurer Graham direct by cash, cheque made out to Cannock Chase Shed or, direct debit giving your name and 'Fees' as Ref if there's room. Cannock Chase Shed. Sort Code 30 96 26 Account Number 47466468.

# Crossword #15

## Across

- 1. In need of a map
- 5. Bank heist, e.g.
- 10. Wished, as a farewell
- 14. Feedbag fill
- 15. Way past plump
- 16. Responsibility
- 17. Teachers at the prom, perhaps
- 19. Revival setting
- 20. Airline's home base
- 21. Early 20th-century art movement
- 22. Walk like a show horse
- 24. Hang back
- 26. Happen upon
- 28. Pricy wheels, slangily
- 31. Street-smart
- 32. Highest point
- 33. Bite off too much
- 35. Pipe material
- 38. Snack bar?
- 40. Military bigwig
- 42. Work on a tan
- 43. "Always on My Mind" singer
- 45. Way to pay
- 46. Copycat
- 47. Like some birthday parties
- 49. Some three-digit numbers
- 53. Before, in verse
- 54. Type of owl
- 55. Gyro holder
- 57. Harbor vessel
- 60. Every which way

1	2	3	4		5	6	7	8	9		10	11	12	13
14					15						16			
17					18						19			
20					21				22	23				
			24	25		26		27						
28	29				30		31							
32					33	34						35	36	37
38					39			40			41			
42					43		44				45			
				46					47	48				
49	50	51						52		53				
54							55		56			57	58	59
60						61	62				63			
64						65					66			
67						68					69			

- 61. Kirk's ship
- 64. Potatoes, perhaps
- 65. Lord's subject
- 66. Doomsayer's sign
- 67. Follow, as advice
- 68. Shopping binge
- 69. "\_\_\_ #1!"

## Down

- 1. Ness, for one
- 2. Where Pearl City is
- 3. Ranch worker
- 4. Cooking meas.
- 5. Elizabeth McGovern's character on "Downton Abbey"
- 6. Home
- 7. Sinner's punishment
- 8. Opposite of WNW

- 9. Defendant in a lawsuit
- 10. Horticulturist's study
- 11. About, old-style
- 12. Conical-cap wearer
- 13. Fragrant compound
- 18. Perimeter
- 23. Talk a blue streak
- 25. Congregation's cry
- 27. Freight
- 28. Overhead items
- 29. Shade of beige
- 30. Example-setters
- 34. Bona fide
- 35. 8 to 11, on TV
- 36. Flower holder
- 37. Outfitted
- 39. Chilling, say

- 41. \_\_\_ and anon
- 44. Sovereign's staff
- 46. Like a cheater's deck
- 48. Run-down car
- 49. Put to shame
- 50. Textile fiber
- 51. Lose ground
- 52. Military blockade
- 56. Nursery purchase
- 58. Kind of ID
- 59. Actor Wilder
- 62. Quick drink
- 63. Theater section

Free printable courtesy of PrintitFree.net

# Project – Cordless Drill Organiser & Battery Charging Station



## Cordless Drill Organizer and Battery Charging Station



### Materials

- 3/4" plywood (1/2 sheet 4'x4') \*can be substituted with 3/4" wood
- 1/4" or 5 mm plywood
- 1 1/4" screws
- wood glue
- sand paper
- 3" screws
- drawer pull

### Cut List

QUANTITY	THICKNESS	WIDTH	LENGTH	MATERIAL	DESC.
1	3/4"	12 1/2"	18"	3/4" plywood	Back
2	3/4"	12 1/2"	10"	3/4" plywood	Sides
2	3/4"	9 1/4"	18"	3/4" plywood	Shelves
4	3/4"	3"	9 1/4"	3/4" plywood	Dividers
4	3/4"	2 1/4"	9 1/4"	3/4" plywood	Bottoms
2	3/4"	3/4"	9 1/4"	3/4" plywood	Outer Bottoms
2	3/4"	3 7/8"	17 7/8"	3/4" plywood	Drawer F/B
2	3/4"	3 7/8"	7 5/8"	3/4" plywood	Drawer Sides
1	1/4"	8 1/8"	16 7/8"	1/4" plywood	Drawer Bottom

\*Note: This organizer fit perfectly with my Ryobi drills (old and new). If the top of the handle, just under the head of your drill is larger than 1 1/2", adjust the width of the bottoms (2 1/4") accordingly.

## Step 1

Cut out all pieces according to the cut list. Get the 4 dividers and bottoms. Mark 3/4" in from each side of the bottom, to center the divider. Pre-drill the bottom piece, apply a bead of glue and secure each divider and bottom together with 1 1/4" screws.



Take one of the shelves. Mark and pre-drill holes to attach the dividers to the shelf. Glue and attach the dividers to the shelf with 1 1/4", make sure the screws are flush or lower with the wood surface. The gap between each divider is 3".

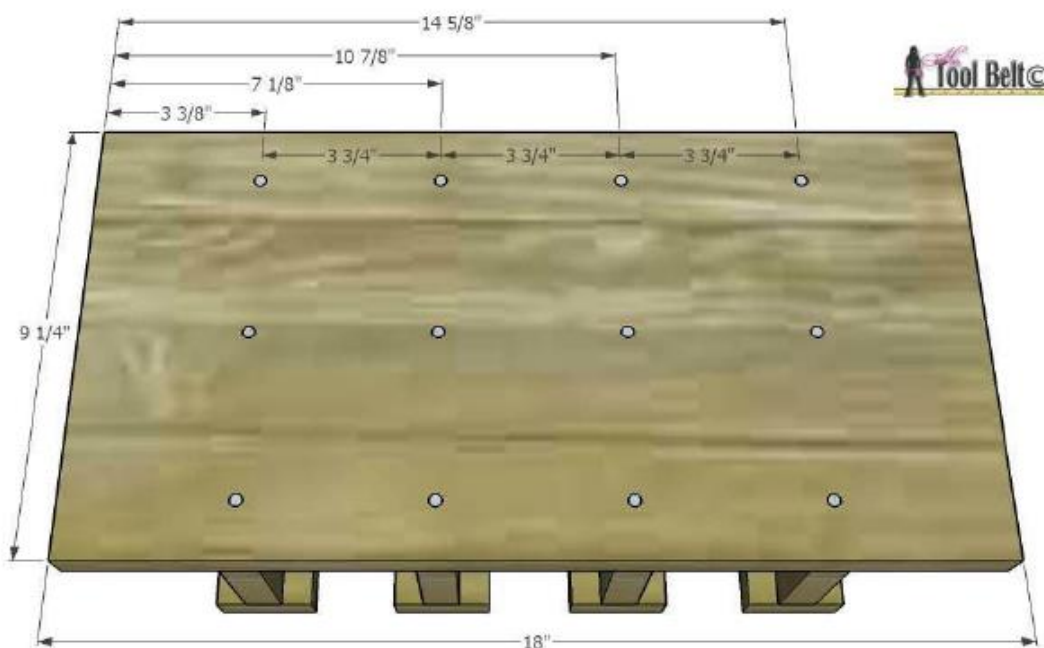

## Step 2

On the 2 sides, measure over and mark 8" and measure up 10 1/2" and mark. Cut between the marks (45 deg), removing the excess triangle. Attach with glue and screws, the bottom side piece at the bottom inside of each side, flush with the front and bottom.



On the sides measure up and mark 4 1/2" and 9 1/4" from the bottom. The gap between the shelves is 4". Pre-drill the sides, glue and screw the shelves between the sides.





Attach the back, between the sides. Secure with glue and screws.



### Step 3

Grab the 4 sides of the drawers. Make dado cuts 1/4" from the bottom, 1/4" deep and 1/4" wide.

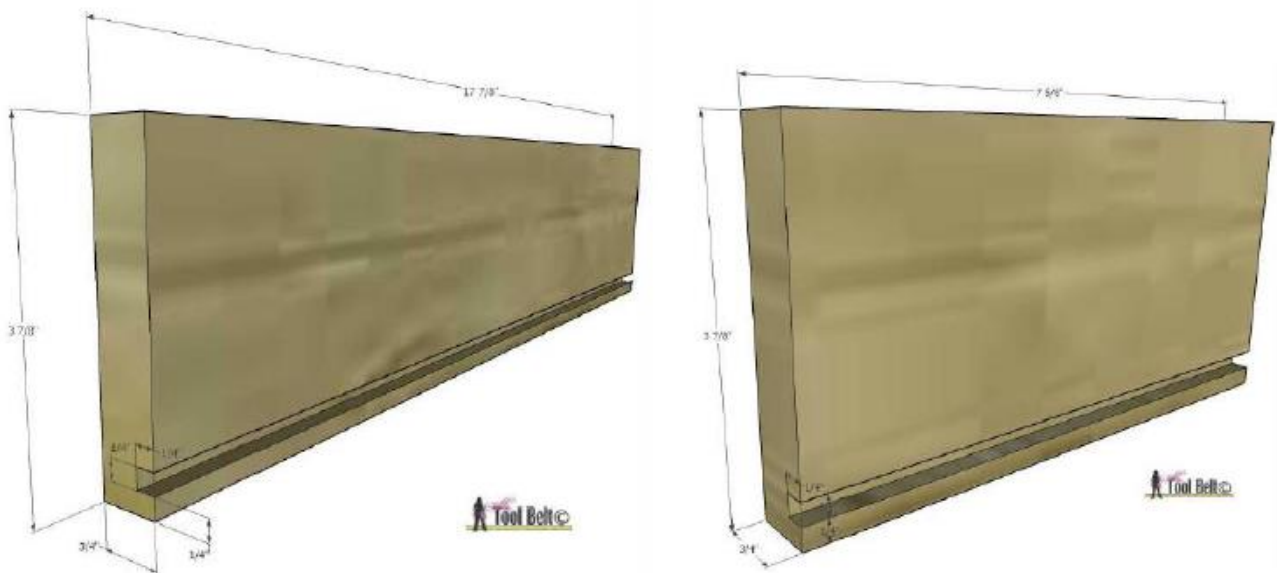

If you have a [Kreg Jig® R3](#) (affiliate), you can make pocket joints on each end of the drawer sides (outside) to attach the drawer together. If not, pre-drill holes through the drawer front and back.

Dry fit the drawer around the drawer bottom, check that it will fit in the drawer slot, trim as necessary. Use glue and 1 1/4" screws to assemble the drawer together.



Attach a drawer pull to the front of the drawer. Sand the cordless drill station as needed.

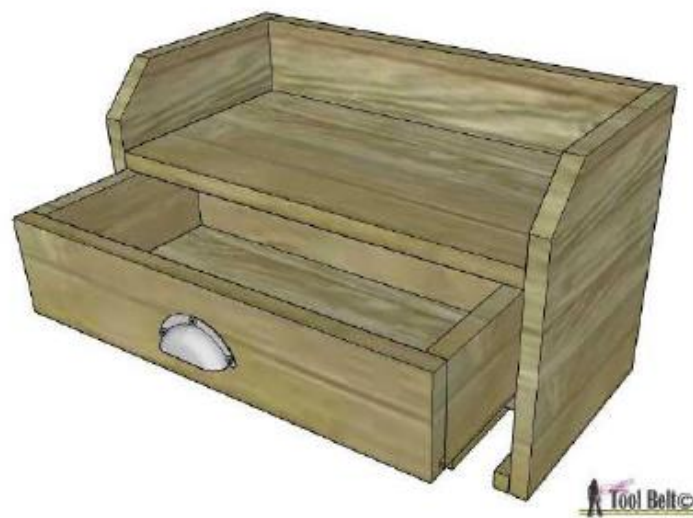

To attach it to the wall, first locate studs in your wall. You'll also probably want it accessible to a power outlet. Once you decide where to hang it, pre-drill holes in the back and attach it to the wall/studs with 3" screws (2 minimum places).

# Wordsearch

## Scottish Premier League

k	h	g	a	d	i	b	q	n	g	s	f	s	g	n	c	f	l	k
r	v	l	o	i	e	t	t	c	y	k	m	f	m	a	a	f	a	q
g	w	k	c	d	r	t	e	b	h	l	t	p	l	i	b	o	c	s
v	t	g	c	f	m	l	i	h	s	q	c	z	z	n	f	k	i	l
h	h	k	j	o	t	v	d	n	u	e	i	a	f	r	y	f	m	u
l	y	s	j	i	n	w	n	i	u	n	z	i	g	e	d	r	e	h
l	k	t	c	u	u	r	c	g	v	f	k	u	z	b	f	w	d	e
p	r	g	e	b	c	g	a	e	f	c	e	o	j	i	v	n	a	a
n	h	m	v	i	q	l	r	m	y	m	u	e	s	h	e	w	c	r
i	a	i	b	k	l	n	l	s	l	h	e	n	d	e	p	h	a	t
j	c	r	m	s	e	x	y	e	v	i	t	a	d	n	r	a	l	s
q	x	r	h	s	t	x	c	h	w	n	k	r	g	n	u	p	n	f
a	k	e	s	s	g	y	o	f	h	r	e	n	s	f	d	d	o	u
u	q	n	s	r	e	g	n	a	r	b	e	i	j	o	y	n	t	y
l	c	q	u	d	e	p	y	o	a	i	t	h	k	t	g	g	l	d
t	d	u	m	k	v	f	b	i	s	c	j	x	t	m	m	l	i	t
q	n	s	t	g	j	o	h	n	s	t	o	n	e	o	i	y	m	v
t	c	u	d	r	a	t	v	y	j	p	z	j	b	i	m	q	a	k
k	r	f	v	e	r	u	w	b	a	n	e	n	g	w	n	c	h	w

aberdeen  
celtic  
dundee united  
hamilton academical  
hearts  
hibernian  
inverness ct  
kilmarnock  
motherwell  
rangers  
st johnstone  
st mirren

## Humour

My doctor asked if anyone in my family suffered from mental illness.

**I said, "No, we all seem to enjoy it."**

My bucket list: keep breathing.

**Camping: where you spend a small fortune to live like a homeless person.**

Just once, I want a username and password prompt to say: "close enough."

**Being an adult is the dumbest thing I have ever done.**

I'm a multitasker. I can listen, ignore and forget all at the same time!

**Retirement to do list: Wake up. Nailed it!**

Went to an antique show and people were bidding on me.

**People who wonder if the glass is half empty or half full miss the point.  
The glass is refillable.**

Retired: Under new management. See spouse for details.

**When you can't find the sunshine . . . be the sunshine.**

I don't have grey hair. I have wisdom highlights.

**Sometimes it takes me all day to get nothing done.**

I don't trip; I do random gravity checks.

**My heart says chocolate and wine, but my jeans say, please, please, please, eat a salad!**

Never laugh at your spouse's choices. You are one of them.

**One minute you're young and fun. The next, you're turning down the car stereo to see better.**

I'd grow my own food if only I could find bacon seeds.

**Losing weight doesn't seem to be working for me, so from now I'm going to concentrate on getting taller.**

My body is a temple: ancient and crumbling.

**Common sense is not a gift. It's a punishment because you have to deal with everyone who doesn't have it.**

I came. I saw. I forgot what I was doing. Retraced my steps. Got lost on the way back. Now I have no idea what's going on

# Humour



# Humour



I thought it was a loaf of bread for a second.

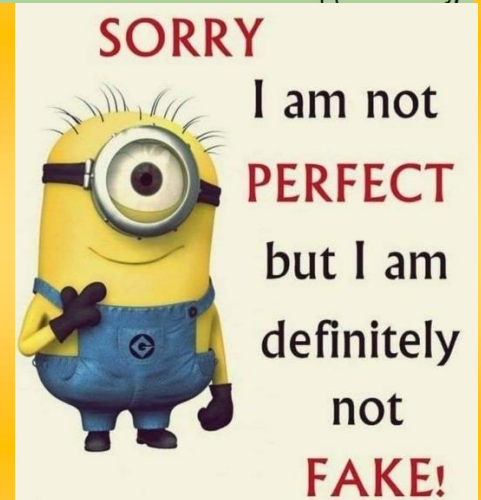

# Humour

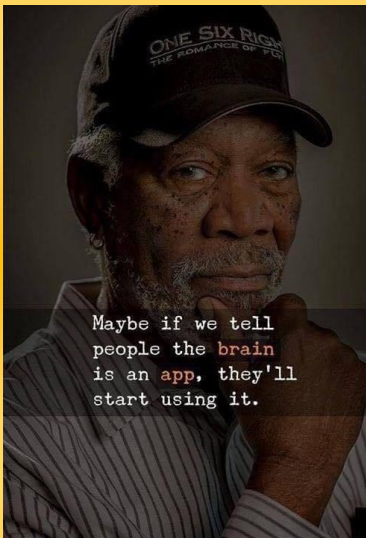

Husband:  
Call ambulance, fast!  
I am having heart attack...

Wife: (took his mobile)  
Quick!! Tell me the password

Husband:  
It's ok! I am feeling  
Better now.



## AS I GET OLDER I REALIZE:

1. I talk to myself, because sometimes I need expert advice.
2. Sometimes I roll my eyes out loud.
3. I don't need anger management. I need people to stop pissing me off.
4. My people skills are just fine. It's my tolerance of idiots that needs work.
5. The biggest lie I tell myself is "I don't need to write that down, I'll remember it."
6. When I was a child I thought nap time was punishment. Now it's like a mini-vacation.
7. The day the world runs out of wine is just too terrible to think about.
8. Even duct tape can't fix stupid, but it can muffle the sound.
9. Wouldn't it be great if we could put ourselves in the dryer for ten minutes; come out wrinkle-free and three sizes smaller?
10. "Getting Lucky" means walking into a room and remembering why I'm there.



Life has knocked me down a few times. It's shown me things I never wanted to see. I've experienced sadness and failures. One thing is certain, I ALWAYS get up!



Sometimes the thoughts in my head get bored and stroll out through my mouth. This is never a good thing.



## Latest Scams

### Pension scam average losses more than double in a year

Pension scams are not a new thing, but they're likely to be more prevalent now that people have more options available to them when it comes to investing or spending their money.

[Here are our tips](#) on how to spot a pension scam and how to report one if you or someone you know has been affected.

[Detect the warning signs](#)

### Fake NHS Covid pass email and texts

Scammers are hoping to cash in on any confusion around the end of pandemic restrictions by sending out lookalike NHS-branded emails and texts that invite you to apply – and pay – for a NHS Covid pass.

The Pass was recently launched so that people can show their Covid vaccine or test status and is free. We show you [examples of the messages](#) and explain how to deal with NHS-related phishing so you don't get caught out.

[Fake vaccine passport scam](#)

### Which? scam alert team

PS Please share this information with your friends, family and neighbours – anyone who may find it helpful. Alternatively, they can [sign up here](#) to receive this directly to their inbox.

You're receiving this email because you signed up to the Which? scam alert service.



# Project – Lap Desk

I C A N D O T H A T

BY MAG RUFFMAN

## Lap Desk

Portable productivity with a nod to steampunk style.

The glorious thing about being self-sufficient is that you can usually figure out ways to create what you need.

My latest need arose after a bad case of Burning Thighs Syndrome, a malady caused by sitting on the couch typing on a laptop computer. With my quadriceps performing as heat sinks for the laptop's toiling battery, I had the hottest legs in Canada.

I switched to writing longhand in a thick journal that never overheated. But to raise the book to a comfortable height for writing I'd have to pile up cushions on my lap, thereby creating a new thermal emergency.

My solution was this perky lap desk, a well-ventilated little unit that adjusts to serve the user's purpose and thigh thickness.

### Oaken-hearted

Start by cutting your desk surface to length with a circular saw (or Japanese-style handsaw if you want perky rear deltoids). By the way, you might be tempted to use pine, but I learned the hard way that pine turns to mush around the insert nuts and the side pieces end up with hip dysplasia. Plus if you drop it on concrete, the side pieces shatter. Just sayin'.

Using a hole saw, create a grid of holes in the surface for ventilation. To accommodate a computer mouse, leave approximately one-third of the surface unviolated by the holey grid.



*Not so hot.* This lap desk lets your computer (and your legs) breathe.

To make the desk surface appear thinner and more elegant, create a subtle ( $\frac{1}{8}$ " ) chamfer on the top and bottom edges of the desk using a block plane.

### Get Jiggy With It

Next, cut out the side pieces using a jigsaw fitted with a scrolling blade. If you don't like my curvy design, sketch your own version right on the wood. Once you've jigsawed one half of the side piece, you can use the offcut to trace a symmetrical match for the other half.

Scrolling blades tend to scoff at perpendicularity so go slowly to prevent warbles and lumps in your finished side pieces. If you get them anyway, use a rasp to take out the wows. Or you can

create The World's Cheapest Drum Sander by gluing sandpaper to one of the cutouts from the desktop holes, and mounting it on a bolt with lock nuts. Install the stem of the bolt in a drill press or a cordless drill and watch this small sanding cylinder erase your jigsawing sins.

Use a contour-sanding flap-wheel to quickly soften all of the edges on the side pieces. A simple sanding sponge works too if you enjoy the meditative aspects of corrective sanding.

Next, sand the desk surfaces lightly, along with the inside walls of the ventilation holes.



*Holey grid.* Inexpensive hole saw kits are available at any home improvement store or hardware store.



*Pattern.* Use the offcut from the first half of your side piece to mark the matching shape on the remaining three cuts.

Then drill three height-adjustment holes in the side pieces using a drill bit that's just a hair bigger than the size of the post on your clamping knobs.

### Black to the Future

Ebonize the pieces, if desired. Ebonizing is fun, cheap and permanent. And because the stain penetrates the wood fibers and creates a chemical reaction with tannins in the wood cells, it doesn't wear as easily as a surface stain.

Oak has a naturally high tannin content but you can accelerate and deepen the effect by pre-treating the bare wood with a concentrated mixture of boiled black tea (for a greenish-black cast), or red wine (for a blue-black tint).

Once the liquid has penetrated and is fairly dry, add a coat of ebonizing "rusty nail" stain (drop a handful of old steel nails, bolts and assorted trail mix – the rustier the better – into a jar of white vinegar. Let it fester for at least two days with the lid off). Enjoy the drama of chemistry as the wood instantly turns deep black. For a deeper hue, add a second coat of beverage followed by more ebonizing stain.

While you're ebonizing, make sure to treat a piece of oak moulding that you'll glue onto the desk surface later to act as a ledge that keeps books and computers from slipping off. Sand the moulding before staining to remove any goop or tool marks from the mill.

When it dries the oak grain will be hairy and splintery, so lightly sand all surfaces with #150-grit sandpaper.

### Gloss-eyed

Next, give all pieces a clear coat. (I like acrylic driveway sealer because it's crazy-indestructible.)



**On the cheap.** Glue a piece of sandpaper around a hole cutout, then mount it on a bolt with lock nuts – instant drum sander!

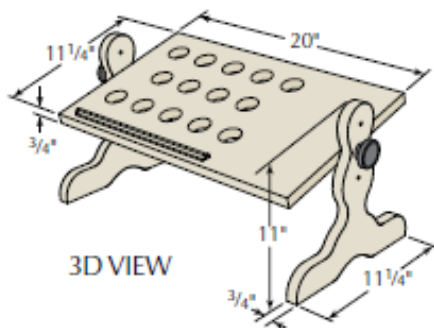

3D VIEW

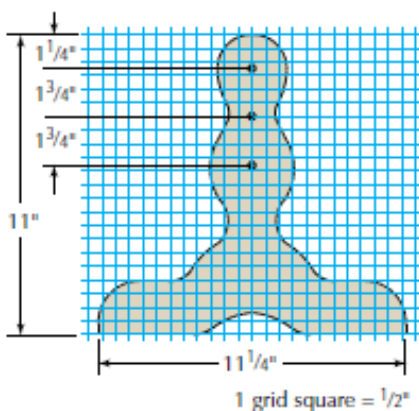

SIDE PATTERN

The clear coat might raise the grain again, so lightly sand after the first coat dries then apply a top coat. (Acrylic driveway sealer dries a bit shiny so I rub it with #0000 steel wool after it's cured to bring down the gloss.)

Now glue and clamp the moulding ledge onto the lower edge of the desk surface. If there's any glue squeeze-out, let it set up a bit before removing it with a scraper.

Finally, drill holes for the insert nuts using a bit diameter that matches the shaft of the insert nut (not including the threads). Drilling into end grain can be a cheek-sucking adventure in steering. Practice on scrap in a vise, attempting to keep the bit plumb. When you do it for real you might want a helper eyeballing

### Supplies

Lee Valley  
leevalley.com or 800-871-8158

- 1 ■ 1/4-20 insert nuts  
#00M90.01, \$6.90/10
- 2 ■ 1 3/4" clamping knobs (male)  
#00M56.11, \$2.30

Prices correct at time of publication.

## Lap Desk

NO.	ITEM	DIMENSIONS (INCHES)			MATERIAL
		T	W	L	
1	Top	3/4	11 1/4	20	Oak
2	Sides	3/4	11 1/4	11	Oak
1	Moulding strip	1/2	1/2	12	Oak

the angle of your drill bit and screaming directional cues. Or not.

Finally, use a large slot-head screwdriver to screw each insert nut into the pilot hole until it's flush with the surface. Then assemble your lap desk with the clamping knobs.

You'll want to take your new lap desk everywhere including car trips, because most passenger seats lack tray tables – critical for navigational responsibilities and assembling snacks for the driver. **PWM**

*Mag is a Canadian woodworker, television producer, writer, comedian and actress. Read her (very funny) blog at [toolgirl.com](http://toolgirl.com).*

### Go Online FOR MORE ...

For links to all these online extras, go to:

► [popularwoodworking.com/aug11](http://popularwoodworking.com/aug11)

**ARTICLE:** Read Mag's additional tips for the Lap Desk.

**PLAN:** Download the free SketchUp plan for the Lap Desk.

**ARTICLES:** All the "I Can Do That" articles are free online.

Download the complete "I Can Do That" manual:

► [popularwoodworking.com/icandothat](http://popularwoodworking.com/icandothat)

Our products are available online at:

► [ShopWoodworking.com](http://ShopWoodworking.com)

### About This Column

Our "I Can Do That" column features projects that can be completed by any woodworker with a modest (but decent) kit of tools in less than two days of shop time, and using raw materials that are available at any home center. We offer a free online manual in PDF format that explains all the tools and shows you how to perform the basic operations in a step-by-step format. Visit [ICanDoThatExtras.com](http://ICanDoThatExtras.com) to download the free manual.



# Answers to Puzzles

## Solution for Crossword #15

1	L	2	O	3	S	4	T		5	C	6	A	7	P	8	E	9	R		10	B	11	A	12	D	13	E
14	O	A	T	S				15	O	B	E	S	E							16	O	N	U	S			
17	C	H	A	P				18	E	R	O	N	E	S						19	T	E	N	T			
20	H	U	B					21	D	A	D	A				22	P	R	A	N	C	E					
				24	L	A	G			26	E	N	C	O	U	N	T	E	R								
28	B	E	E	M	E	R				30					31	C	A	N	N	Y							
32	A	C	M	E						33	O	V	E	R	D	O				35	P	V	C				
38	G	R	A	N	O	L	A							40	G	E	N	E	R	A	L						
42	S	U	N					43	N	E	L	S	O	N						45	V	I	S	A			
								46	M	I	M	I	C			47	T	H	E	M	E	D					
49	A	R	E	A	C	O	D	E	S					52					53	E	R	E					
54	B	A	R	R	E	D				55	P	I	T	A					57	T	U	G					
60	A	M	O	K						61	E	N	T	E	R	P			63	R	I	S	E				
64	S	I	D	E						65	L	I	E	G	E				66	O	M	E	N				
67	H	E	E	D						68	S	P	R	E	E				69	W	E	R	E				

## Scottish Premier League

k	h	g	a	d	i	b	q	n	g	s	f	s	g	n	c	f	l	k
r	v	l	o	i	e	t	t	c	y	k	m	f	m	a	a	f	a	q
g	w	k	c	d	r	t	e	b	h	l	t	p	l	i	b	o	c	s
v	t	g	c	f	m	l	i	h	s	q	c	z	z	n	f	k	i	l
h	h	k	j	o	t	v	d	n	u	e	i	a	f	r	y	f	m	u
l	y	s	j	i	n	w	n	i	u	n	z	i	g	e	d	r	e	h
l	k	t	c	u	u	r	c	g	v	f	k	u	z	b	f	w	d	e
p	r	g	e	b	c	g	a	e	f	c	e	o	j	i	v	n	a	a
n	h	m	v	i	q	l	r	m	y	m	u	e	s	h	e	w	c	r
i	a	i	b	k	l	n	l	s	l	h	e	n	d	e	p	h	a	t
j	c	r	m	s	e	x	y	e	v	i	t	a	d	n	r	a	l	s
q	x	r	h	s	t	x	c	h	w	n	k	r	g	n	u	p	n	f
a	k	e	s	s	g	y	o	f	h	r	e	n	s	f	d	d	o	u
u	q	n	s	r	e	g	n	a	r	b	e	i	j	o	y	n	t	y
l	c	q	u	d	e	p	y	o	a	i	t	h	k	t	g	g	l	d
t	d	u	m	k	v	f	b	i	s	c	j	x	t	m	m	l	i	t
q	n	s	t	g	j	o	h	n	s	t	o	n	e	o	i	y	m	v
t	c	u	d	r	a	t	v	y	j	p	z	j	b	i	m	q	a	k
k	r	f	v	e	r	u	w	b	a	n	e	n	g	w	n	c	h	w